

SWCHS TECHNOLOGY & ART YEAR 8 CHOICES 2024

A guide for students and parents that outlines each of the courses on offer for Year 9 students in Technology and Art.

COURSE OVERVIEW

TECHNOLOGY

Within Technology there are 4 options that students can choose to study in Year 9. All four courses continue into GCSE in Year 10, with Product Design and 3D Design – Architecture also continuing into A Level. Please note that timetabling constraints mean that we cannot guarantee to accommodate the individual requests of every student.

At GCSE subjects indicated with # are specialist versions of a single Art GCSE specification. Students will be able to study a maximum of two of these subjects in Year 9, but will then have to opt for only one in Years 10 and 11

- PRODUCT DESIGN
- 3D DESIGN – ARCHITECTURE #
- TEXTILES #
- FOOD PREPARATION & NUTRITION

ART

Within Art there are 2 options that students can choose to study in Year 9. Both courses continue into GCSE in Year 10 and also to A Level.

- ART CRAFT & DESIGN #
- 3D ART #

WHERE COULD DESIGN TAKE YOU?

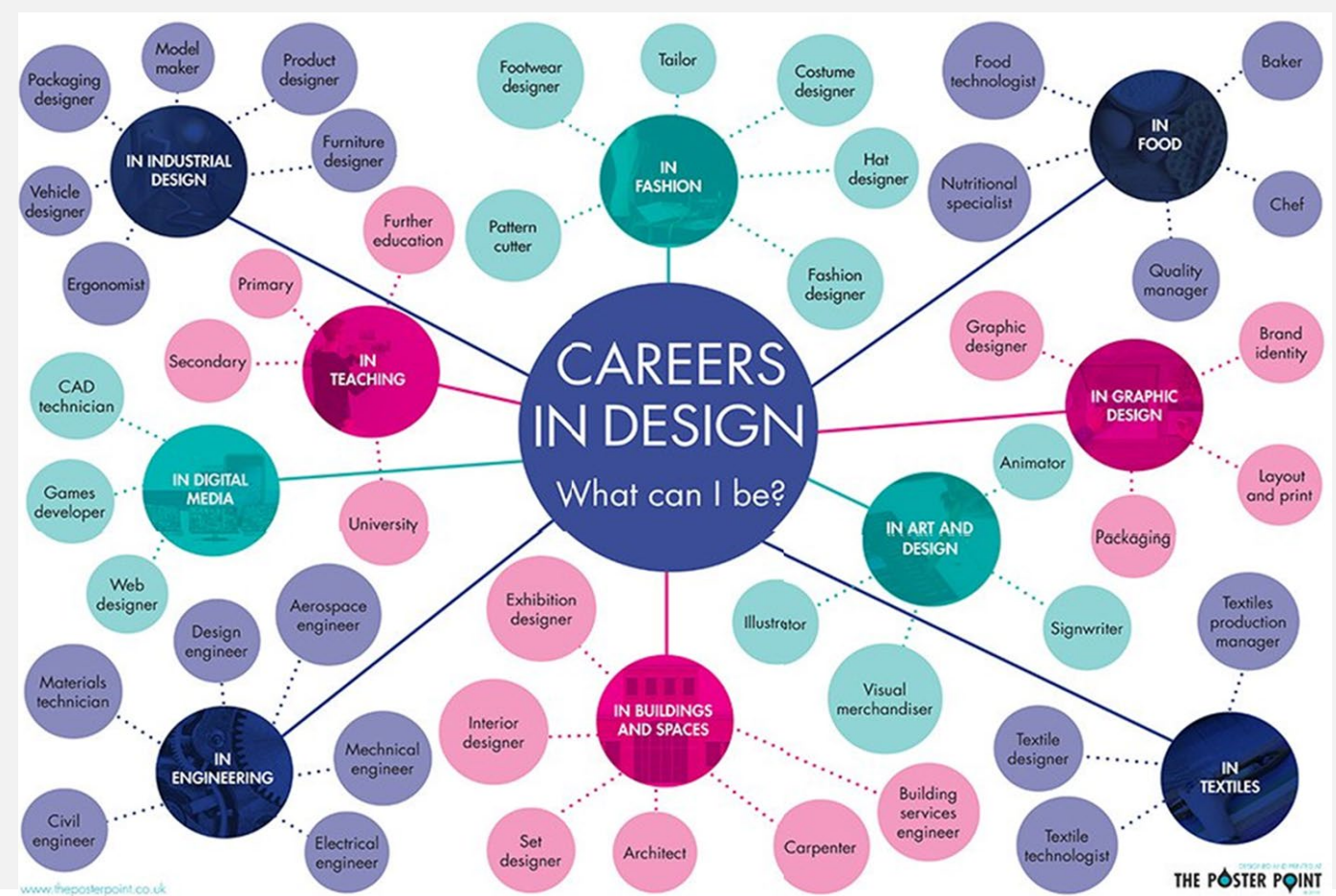

THE TECHNOLOGY AND ART EXHIBITION

At the end of Year 11, all GCSE and A Level Design and Technology and Art students get the chance to exhibit their Year 11 work at the SWCHS Design and Technology and Art Exhibition. This is a fantastic opportunity for students to showcase their work, and an opportunity for not only friends and family to see their talents and creativity on display, but a chance for professionals from the local area to see the fantastic work that our students produce!

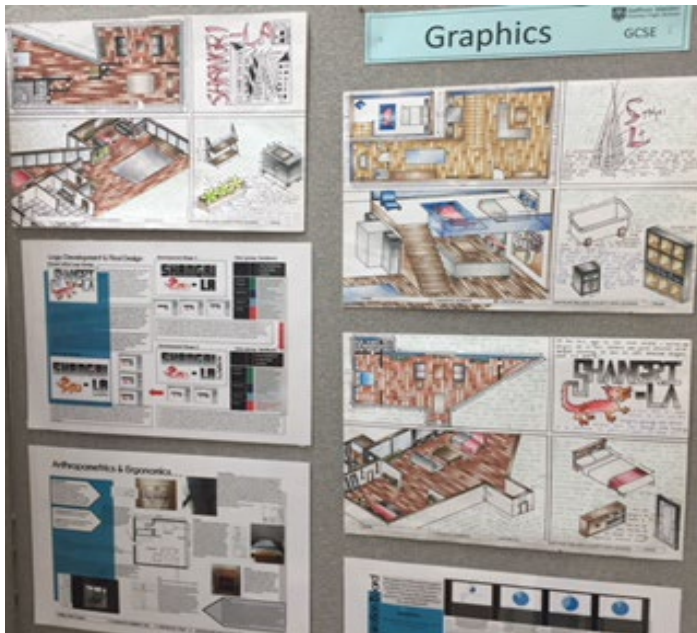

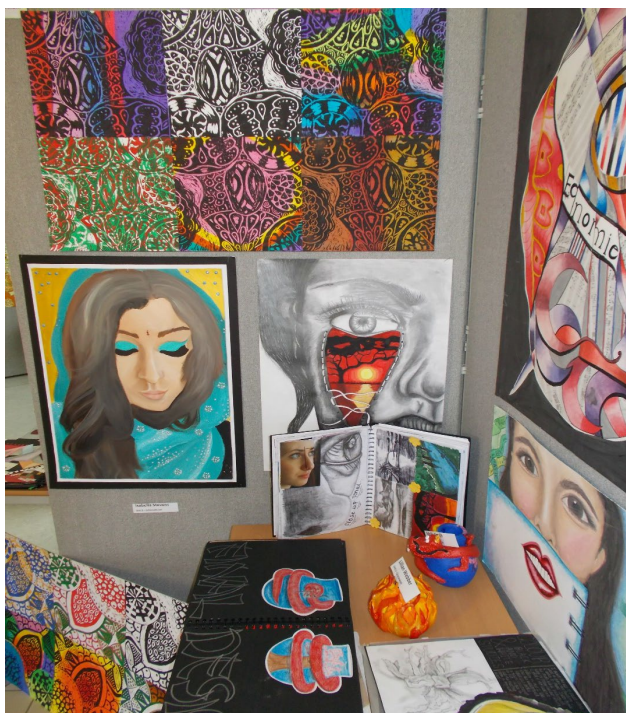
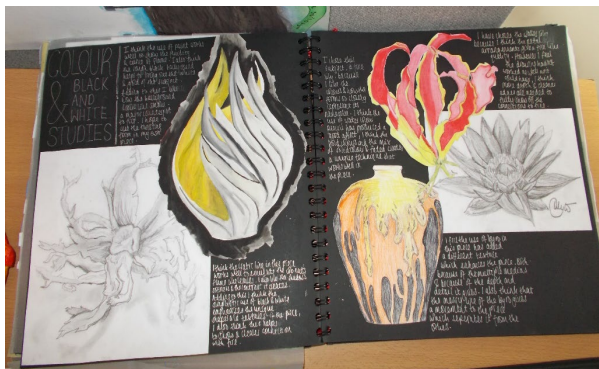

Come and see the creative, innovative and high quality work that our Year 11 and A Level students produce at the Design Technology and Art Exhibition in May!

Social Media



Please visit our *Instagram* account to see some of the amazing work produced by our students across the different Technology subjects.

swchs_dt_department

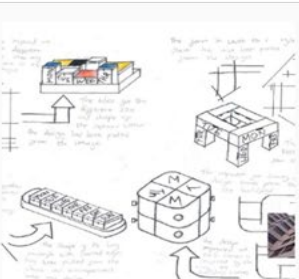
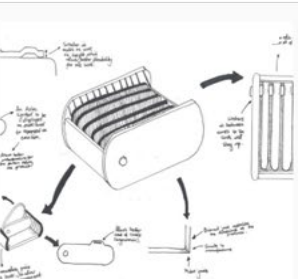
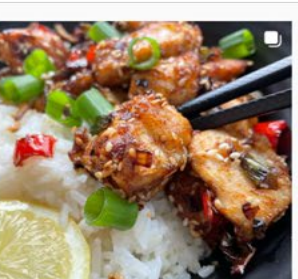
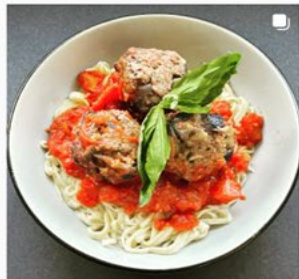
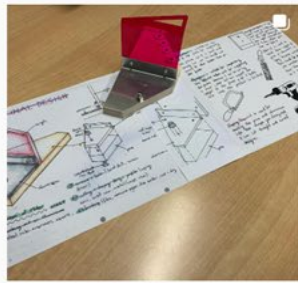
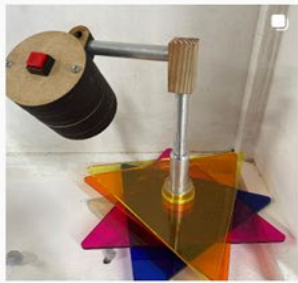

PRODUCT DESIGN

If you enjoyed product design in Years 7 and 8, then this is the course for you!

What will I do in Year 9?

This exciting course builds on students' experience of Product Design in Years 7 and 8, developing their skills and knowledge. It also introduces engineering processes and manufacturing techniques to further enrich their experience within the subject.

During year 9, students participate in two units of study that conclude with a series of design, practical, and user-centered tasks. These activities provide a comprehensive overview of designing and crafting a variety of innovative and creative products. In the practical tasks, students get to work with a diverse range of materials, processes, and machinery, helping to build confidence in preparation for the subject at GCSE for those who decide to pursue the course further.

Frequently asked questions:

Q – Who can take this course?

A – *Everyone! We cater for all learners and teach you everything that you need to know in order to succeed. All we ask is that you come with a passion and commitment for the subject and that you are prepared to work hard!*

Q – How much time will I get to spend doing practical?

A – *Lots! We know that our Product Design students love making, and whilst we have to cover some theory based knowledge, you will making products as much as possible in order to develop your practical skill set.*

Looking further ahead: GCSE Course Outline:

This course develops the knowledge and understanding of different materials and manufacturing processes in order to design and make, with confidence, prototypes in response to issues, needs, problems and opportunities. Students learn how to take design risks, helping them to become resourceful, innovative and enterprising citizens. Through the critique of the outcomes of design and technology activity, both historic and present day, students develop an understanding of its impact on daily life and the wider world and understand that high-quality design and technology is important to the creativity, culture, sustainability, wealth and wellbeing of the nation and the global community.

Year 10 content

Students immerse themselves in focused projects for the majority of the year, honing both theoretical understanding and practical skills. In June of Year 10, students undertake the main coursework component, which constitutes 50% of the overall GCSE grade. Students will undertake a single design and manufacture project form a set contextual challenge set by the exam board. The main investigation and research section of the coursework is completed within this year.

Year 11 content

Students continue with the coursework project, dedicating a significant portion of the year to the design and manufacture stages —from the initial concept to the creation of the final physical outcome. Upon completing the coursework, students follow a well-structured revision plan for the 1 hour and 45 minute written exam, which accounts for the remaining 50% of their overall grade. In the written exam, students will begin with a 'core section' assessing their understanding of various materials, processes, and principles of design & technology. Subsequently, they will delve deeper into the topic of Timbers, which will cover the remaining portion of the examination.

For students aspiring to deepen their understanding and pursue further study in the subject, there is a direct progression onto our A-level course.

PRODUCT DESIGN

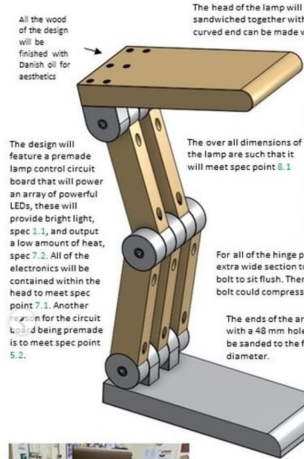

All the wood of the design will be finished with Danish oil for aesthetics.

The head of the lamp will be constructed from multiple layers of oak that will be sandwiched together with glue. This is so that the cut-out for the electronics and the curved end can be made with the facilities available at a school for spec point 5.2.

MS socket shoulder screw, this bolt will have a long shoulder to allow the hinge parts to rotate separately without threading themselves into each other and locking up the hinge.

The design will feature a pre-made lamp control circuit board that will power an array of powerful LEDs, these will provide bright light, spec 1.3, and output a low amount of heat, spec 7.2. All of the electronics will be contained within the head to meet spec point 7.1. Another reason for the circuit board being pre-made is to meet spec point 5.2.

The over all dimensions of the lamp are such that it will meet spec point 8.1.

For all of the hinge parts there will be variants that have an extra wide section to the central hole to allow the head of the bolt to sit flush. There will also be a tapped variant so that the bolt could compress the hinge together.

The ends of the arms will be cut with a 48 mm hole drill bit and will be sanded to the final 49mm diameter.

MS bolts as they are easy to source in a school to meet spec 5.2.

The base will be sand cast aluminium as it is a light metal so will meet spec point 1.3 but is heavier than wood so will prevent the product from being top heavy and unstable. The base has been lengthened since the modelling stage as the user commented that with the widened base the length to width ratio was wrong and as such the base should be lengthened.

The 5 anchor pieces that secure the hinges to the base and head of the lamp will be cut, sanded and milled from a sandcast as the curved top would be difficult to attain otherwise, this means it will meet spec 5.2 & 5.3, the sand casting will be a two part mold due to the size of the part. The parts are aluminium as it is a low density metal and will meet spec points 1.3 & 6.1. The corners of the part will be rounded to protect the user and make the design more pleasant to use.

The holes in the arms will line up with the holes on the pucks and will be drilled to two different diameters so that the heads of the MS bolts will sit flush with the design.

Here you can see the sunken head bolt that will join up the hinge pieces that allow the lamp to be adjusted to meet spec point 3.1. The pucks will be turned on the lathe to the dimensions on the engineering drawing, they will be aluminium to meet spec points 1.3 & 6.1. As the arms are attached to the hinge via bolts there will be MS tapped holes on the pucks at the angles prescribed on the engineering drawing.

The arms will be made from oak as it meets spec points 6.1 & 9.2, it will be FSC sourced to meet spec point 6.2.

The design is made to fold down to a smaller size, hence the offsetting of the arms, this will meet spec point 1.2.

INITIAL DESIGN 1

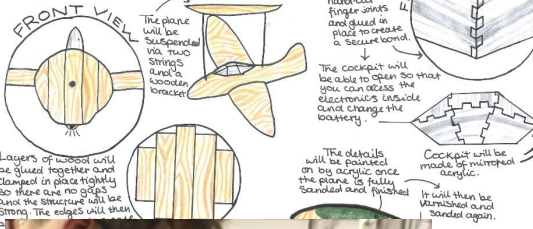

The cockpit will be created via 6 pieces of oak and will be finished with Danish oil for aesthetics.

The plane will be suspended via two strings and a wooden bracket.

The cockpit will be able to open so that you can access the electronics inside and change the battery.

The details will be painted on by acrylic once the plane is fully sanded and finished.

Cockpit will be made of mirrored acrylic.

It will then be varnished and sanded again.

Layers of wood will be glued together and sanded in place tightly so there are no gaps. The structure will be strong. The edges will then be sanded.

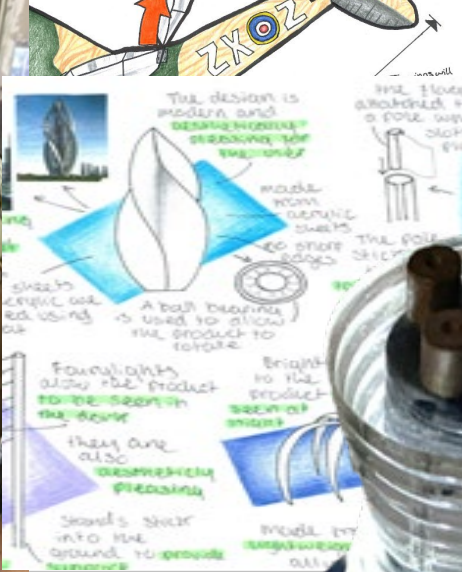

The design is modern and sleek, looking like a modern lamp.

A ball bearing is used to allow the product to rotate.

Four lights allow the product to be seen from the side.

They are also aesthetically pleasing.

Sand's stair into the ground to provide support.

Made from sustainable materials.

The head is sanded and a four step step for the ball bearing.

GO SHORT STEPS.

Bright to the product.

Made by sustainable materials.



INITIAL DESIGN



The bamboo light is made out of real bamboo that is sanded to shape. First get a piece of bamboo about 1 meter long and roughly 20mm in diameter. Get a template with pins in the wood so the curve is 20mm from the inside edge.

The bamboo will be sanded to give it a smooth finish. The leaves will be attached to the side of the bamboo.

To attach the leaves to the bamboo holes will be drilled into the side and the stem will be glued into it. Then drilling into an angle so the leaves will be pointing down.

There will be four small legs on the bottom of the foot with pads to stop any scratching of the table. They will be 15mm in diameter.

The six LEDs in a small box will be attached to the box to attach the box to the lamp. It will glue into the hole in the top of the bamboo. The box will be attached together using a simple butt joint due to the size of it.

The bamboo will be sanded to give it a smooth finish. The leaves will be attached to the side of the bamboo.

The bamboo will be sanded to give it a smooth finish. The leaves will be attached to the side of the bamboo.

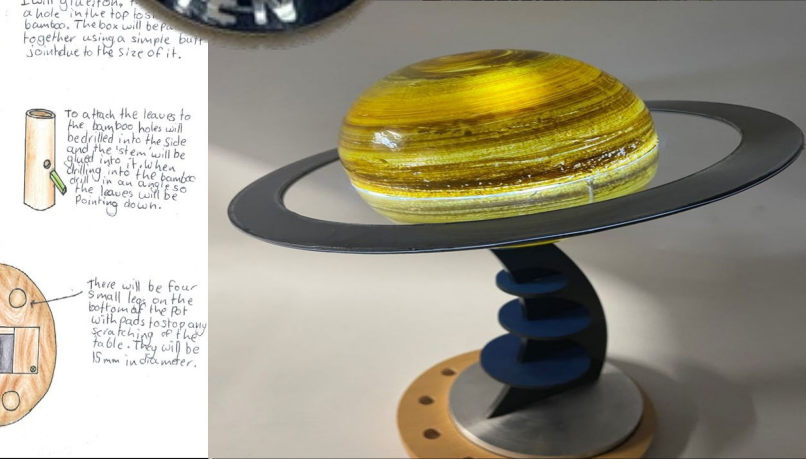

3 D DESIGN – ARCHITECTURE

If you enjoyed **Graphics** in Years 7 and 8 then this is the course for you!

W h a t w i l l I d o i n Y e a r 9 ?

This highly creative course is based on three-dimensional design in the form of Architecture that builds on students experience of Graphics in Years 7 and 8.

In Year 9, students engage in two units that blend creative thinking whilst introducing architectural techniques, providing a fulfilling, and rewarding experience. These projects expose students to a variety of skills, including the use of industry-standard CAD/CAM programs and machinery for creative design, prototyping, and crafting functional and visually appealing interiors and architecture. The course mirrors real-world design practices, offering opportunities for both collaborative teamwork and individual work. Throughout, students enhance their communication skills, preparing them to effectively present themselves as designers, especially if they choose to pursue this course in subsequent years.

F r e q u e n t l y a s k e d q u e s t i o n s :

Q – Who can take this course?

A – *Everyone! We cater for all learners and teach you everything that you need to know in order to succeed. All we ask is that you come with a passion and commitment for the subject and that you are prepared to work hard!*

Q – Do we get to do lots of practical?

A – *Yes, in each project taught across all years there is the opportunity to build!*

L o o k i n g f u r t h e r a h e a d : G C S E C o u r s e O u t l i n e

Examination board: Edexcel

Assessment

Component 1: Coursework 60% of GCSE award

Component 2: Externally set assignment (set by exam board) 40% of GCSE award

Year 10 content

Students embark on Component 1, which involves producing a personal portfolio including a sketchbook and a three-dimensional model. They undergo the design cycle, involving the analysis of the project theme, research, investigation, design, development, physical manufacturing of an architectural model, and evaluation. The theme for this project is 'Organic Architecture,' aimed at fostering an appreciation for the profound influence of the natural world on architecture. Additionally, it raises awareness of the importance of the environment and sustainable issues.

Year 11 content

Students continue to work on completing Component 1, and they also undertake a supportive mock examination project that contributes to the assessment of Component 1. In early January, the exam board releases Component 2. Students are provided with a specific brief by the exam board, tasked with designing and creating a 3D outcome of their choice in response to the given theme. This process mirrors the journey of Component 1, involving the creation of a sketchbook with research, designs, and development work to aid in producing the final model. The final model is produced during a designated 10-hour exam period, during which students are required to work independently in controlled exam conditions.

For students aspiring to deepen their understanding of architecture and pursue further study in the subject, there is a direct progression onto our A-level course.

3D DESIGN - ARCHITECTURE



For more information about this course, please contact Mr Bennett – dbennett@swchs.net

TEXTILES

If you enjoyed **Textiles** in Years 7 and 8 then this is the course for you!

What will I do in Year 9?

Textiles is a creative subject that involves the selection, manipulation and creation of new fabrics and uses a range of technical processes to create exciting practical outcomes. Throughout Year 9, students work in sketchbooks and are taught a variety of art and designing techniques to help communicate their design intentions. Students experiment with different media, including photography and CAD to design and manipulate their own textile ideas. Students also learn how to do various printed textiles, decorative techniques, fashion illustration and presentation techniques.

The course is suitable for all students and can be adapted to suit personal preferences i.e. menswear or womenswear.

Frequently asked questions:

Q – Who can take this course?

A – *Everyone! We cater for all learners and teach you everything that you need to know in order to succeed. All we ask is that you come with a passion and commitment for the subject and that you are prepared to work hard!*

Q – Can boys take this course?

A – *Absolutely!*

Looking further ahead: GCSE Course Outline

The course is primarily fashion based and covers a variety of design and make projects. The course is suitable for all students and can be adapted to suit personal preferences i.e. menswear or womenswear. The course encourages creative thinking and allows students the freedom to explore their own personal influences.

Examination board: Edexcel

Assessment

Component 1: Coursework 60% of GCSE award

Component 2: Externally set assignment (set by exam board) 40% of GCSE award

Year 10 content

Students begin their component 1 coursework in the form of a personal portfolio. The coursework project comprises of a sketchbook, garment and portfolio pages. Students will complete a design and make project using an internally set assignment. Throughout the project students will produce a variety of sketchbook pages of research, designs and practical textile samples. Students then use their inspiration, designs and development work to make a corset or jacket inspired by their theme.

Year 11 content

Students continue to work on completing Component 1, and they also undertake a supportive mock examination project that contributes to the assessment of Component 1.

In early January, the exam board releases Component 2. Students are given a set brief by the exam board and are asked to design and make a fashion garment/accessory. Students create a sketchbook featuring research, designs, development work to help produce their final product. The final model is produced during a designated 10-hour exam period, during which students are required to work independently in controlled exam conditions.

For students aspiring to deepen their understanding of textile design and fashion, there is an opportunity to study it at A Level through the Art & Design Textiles course.

TEXTILES



WOMENSWEAR...



MENSWEAR...



FOOD PREPARATION & NUTRITION

If you enjoyed **Food** in Years 7 and 8 then this is the course for you!

What will I do in Year 9?

Leading on from Food Technology in Years 7 and 8, our fresh and exciting Food Preparation and Nutrition course equips students with an array of culinary techniques, as well as knowledge of nutrition, food traditions and kitchen safety.

Whilst practical skills are an important focus of the Food Preparation and Nutrition course, we also begin to introduce students to develop knowledge in the following key areas: food, nutrition and health, food science, food safety, food provenance and food choice.

This course will inspire and motivate students, opening their eyes to a world of career opportunities and giving them the confidence to cook with ingredients from across the globe!

Please note that parents need to be willing to provide ingredients on a regular basis and that students will need to practise their cooking skills at home in order to develop and extend their practical ability.

Frequently asked questions:

Q – How often will I cook?

A – *You will do practical work in most of your double lessons. We know that our food students love to cook but we also do theory work that will support and develop your food knowledge.*

Looking further ahead: GCSE Course Outline

This is a subject with a great variety of content where students are given the opportunity to work both independently and as part of a team, investigating foods, developing culinary skills and techniques, exploring elements of food science, use of ingredients and nutrition. While there are ample opportunities for hands-on practical work, the curriculum also emphasises a considerable theoretical focus throughout the course.

Examination board: AQA Food Preparation and Nutrition

Year 10 content

Students will develop their theoretical knowledge and understanding of crucial aspects such as food safety and hygiene, food provenance, production and processing, along with further exploration of scientific principles integral to food preparation. With practical skills, there is a specific focus on fostering creativity in dish selection and enhancing independent culinary abilities.

Year 11 content

Students begin the main Non-Exam Assessment (NEA) coursework, which is divided into two separate tasks; A Food Investigation completed in the autumn term and a Food Preparation assessment completed in the spring term. Together these are worth 50% of the grade.

Task 1 - Food investigation: Students will investigate the working characteristics and the functional and chemical properties of a particular ingredient through practical investigation. They will produce a report which will include research into 'how ingredients work and why'. This component forms 30% of the overall Non-Exam Assessment (NEA) grade.

Task 2 - Food preparation assessment: In this task, students will prepare, cook and present a final menu of three dishes to meet the needs of a specific context. Students must select appropriate technical skills and processes and create 3–4 dishes to showcase their skills. They will then produce their final menu within a single period of no more than 3 hours, planning in advance how this will be achieved. This component forms 70% of the overall Non-Exam Assessment (NEA) grade.

Once these tasks are complete, students follow a well-structured revision plan for the 1 hour and 45 minute written exam, which accounts for the remaining 50% of their overall grade.

FOOD PREPARATION & NUTRITION



For more information about this course, please contact - Ms Ward - SWard@swchs.net

ART CRAFT AND DESIGN

What will I do in Year 9?

Year 9 focuses on developing skills and confidence as artists through experimentation and personal inquiry. The course focuses on building experiences with a wide range of drawing, painting, ceramic and print making processes, as well as investigating diverse and interesting artists.

The year 9 experience focuses on fostering a love of the subject whilst developing skills, creativity and an inquiring mind. During the workshops and practical tasks there is a real focus on creativity, problem solving, critical thinking and learning how to communicate through the visual language of Art. The work undertaken is fun, exciting and developed from a range of starting points.

The course encourages the development of a personal response using a wide range of materials, processes and techniques including drawing from observation and imagination, painting, experimental print making, collage, mixed media and photography. You will also explore how to compile and present work through imaginative use of sketchbooks and design sheets, as well as how to evaluate and annotate

GCSE Course Outline:

Overview

Throughout the GCSE course there are opportunities to visit galleries and museums to build an appreciation of art and design as well as providing a springboard for new projects.

Year 10 content

During Year 10 the themes include natural forms and 'ancient cultures'. The natural forms project focuses on drawing, painting and designing using a wide range of media; developing ideas into print, mixed media and painting. The Ancient cultures project focuses exploring cultures of interest through drawing, painting and research.

Year 11 content

Year 11 expands on the cultural theme, the project focuses on 3D design, developing clay sculptures. The second part of year 11 consists of the externally set task, set by AQA. This consists of a 'lead in period' followed by a practical exam. The GCSE Art course provides an excellent opportunity for students to follow specialist pathways in creative Arts subjects; teaches the required drawing, painting skills, creative understanding and aesthetic appreciation to successfully progress onto A Level courses.

GCSE Course Outline

EXAMINATION BOARD – AQA

Component 1: Coursework 60% of GCSE award

Component 2: Externally set non exam assessment 40% (set by exam board)

ART CRAFT AND DESIGN

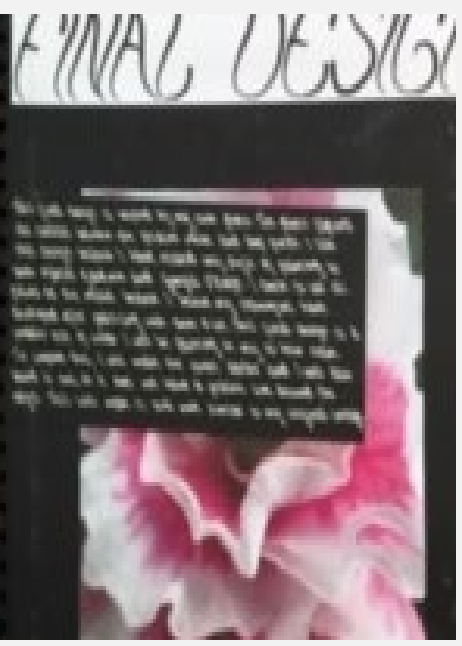
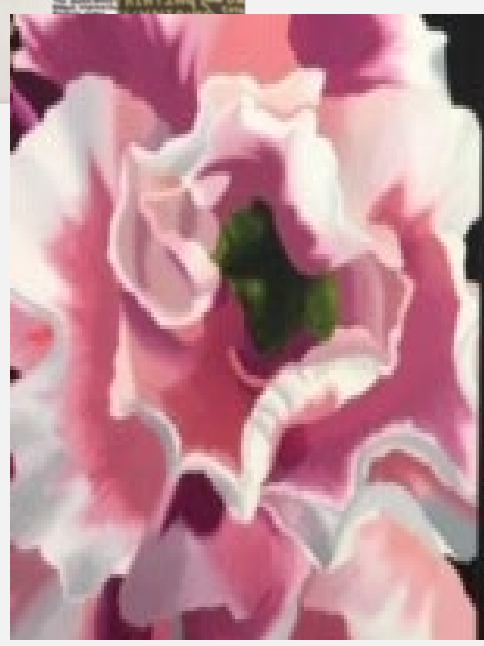

3 D A R T

Year 9 Course Outline

The 3D foundation course focuses on developing their skills and confidence as artists through experimentation and personal inquiry. The course focuses on building students experience with a wide range of drawing, designing and making processes, as well as investigating diverse and interesting artists to inform their ideas. The year 9 experience focuses on fostering a love of the subject whilst developing skills, creativity and an inquiring mind. During the workshops and practical tasks there is a real focus on creativity, problem solving, critical thinking and learning how to communicate through the visual language of Art. Students undertake fun, exciting and investigative work from a range of starting points to assist in building strong foundation of skills, knowledge and understanding. The course will allow students to develop a personal response using a wide range of three-dimensional materials, including clay construction, wire, card and modrock. Students also explore how to compile and present their work through imaginative use of sketchbooks and design sheets, as well as how to evaluate and annotate their own work.

Overview

Throughout the GCSE course there are opportunities to visit galleries and museums to build an appreciation of art and design as well as providing a springboard for new projects. The GCSE course focusses on the continued development of subject knowledge and fostering independent creativity across a range of coursework projects with a focus on making three-dimensional works of Art.

Year 10 content

Year 10 projects are based on the theme of 'natural form's and 'Sculptural heads'. The natural forms project focuses on drawing and designing range of media and developing ideas three dimensional ceramic pieces. The sculptural project focuses on clay construction techniques, glazing and decorative techniques for ceramics.

Year 11 content

The year 11 project is based on a cultural theme, the project focuses on three-dimensional design, developing clay and other three-dimensional materials. The second part of year 11 consists of the externally set task, set by AQA. This consists of a 'lead in period' followed by a practical exam conditions. The GCSE Art course provides an excellent opportunity for students to follow specialist pathways in creative Arts subjects; teaches the required drawing, painting, creative understanding and aesthetic appreciation to successfully progress onto A Level courses. Studying three-dimensional Design provides an excellent platform to further study at university in all creative subjects. Art courses offered within the art department provide a high level of specialist support and challenge for students of all abilities. The GCSE 3D Art course teach a high level of practical skills, a vast array of media and creative processes whilst celebrating individual creativity, embracing experimentation and independent learning.

EXAMINATION BOARD – AQA

Component 1: Coursework 60% of GCSE award

Component 2: Externally set non exam assessment
40% (set by exam board)

3 D ART

